

FLEX I/O Digital Input Modules

Catalog numbers 1794-IB8, 1794-IB16, 1794-IB32

Table of Contents

Topic	Page
Important User Information	2
Environment and Enclosure	3
Preventing Electrostatic Discharge	3
European Hazardous Location Approval	4
North American Hazardous Location Approval	5
Install Your Digital Input Module	7
Configure Your Input Module	13
Specifications	16

Important User Information

Solid-state equipment has operational characteristics differing from those of electromechanical equipment. Safety Guidelines for the Application, Installation, and Maintenance of Solid-State Controls (Publication [SGI-1.1](#) available from your local Rockwell Automation Sales Office or online at <http://www.rockwellautomation.com/literature/>) describes some important differences between solid-state equipment and hard-wired electromechanical devices. Because of this difference, and also because of the wide variety of uses for solid-state equipment, all persons responsible for applying this equipment must satisfy themselves that each intended application of this equipment is acceptable.





In no event will Rockwell Automation, Inc. be responsible or liable for indirect or consequential damages resulting from the use or application of this equipment.

The examples and diagrams in this manual are included solely for illustrative purposes. Because of the many variables and requirements associated with any particular installation, Rockwell Automation, Inc. cannot assume responsibility or liability for actual use based on the examples and diagrams.

No patent liability is assumed by Rockwell Automation, Inc. with respect to use of information, circuits, equipment, or software described in this manual.

Reproduction of the contents of this manual, in whole or in part, without written permission of Rockwell Automation, Inc., is prohibited.

Throughout this manual, when necessary, we use notes to make you aware of safety considerations.

	WARNING: Identifies information about practices or circumstances that can cause an explosion in a hazardous environment, which may lead to personal injury or death, property damage, or economic loss.
	ATTENTION: Identifies information about practices or circumstances that can lead to personal injury or death, property damage, or economic loss. Attentions help you identify a hazard, avoid a hazard, and recognize the consequences.
	SHOCK HAZARD: Labels may be on or inside the equipment (for example, drive or motor) to alert people that dangerous voltage may be present.
	BURN HAZARD: Labels may be on or inside the equipment (for example, drive or motor) to alert people that surfaces may reach dangerous temperatures.
IMPORTANT	Identifies information that is critical for successful application and understanding of the product.

Environment and Enclosure



ATTENTION: This equipment is intended for use in a Pollution Degree 2 industrial environment, in overvoltage Category II applications (as defined in IEC publication 60664-1), at altitudes up to 2000 m (6562 ft) without derating.

This equipment is considered Group 1, Class A industrial equipment according to IEC/CISPR Publication 11. Without appropriate precautions, there may be potential difficulties ensuring electromagnetic compatibility in other environments due to conducted as well as radiated disturbance.

This equipment is supplied as open-type equipment. It must be mounted within an enclosure that is suitably designed for those specific environmental conditions that will be present and appropriately designed to prevent personal injury resulting from accessibility to live parts. The enclosure must have suitable flame-retardant properties to prevent or minimize the spread of flame, complying with a flame spread rating of 5VA, V2, V1, V0 (or equivalent) if non-metallic. The interior of the enclosure must be accessible only by the use of a tool. Subsequent sections of this publication may contain additional information regarding specific enclosure type ratings that are required to comply with certain product safety certifications.

In addition to this publication, see:

- Industrial Automation Wiring and Grounding Guidelines, Rockwell Automation publication [1770-4.1](#), for additional installation requirements.
- NEMA Standard 250 and IEC 60529, as applicable, for explanations of the degrees of protection provided by different types of enclosure.

Preventing Electrostatic Discharge



ATTENTION: This equipment is sensitive to electrostatic discharge, which can cause internal damage and affect normal operation. Follow these guidelines when you handle this equipment:

- Touch a grounded object to discharge potential static.
 - Wear an approved grounding wriststrap.
 - Do not touch connectors or pins on component boards.
 - Do not touch circuit components inside the equipment.
 - Use a static-safe workstation, if available.
 - Store the equipment in appropriate static-safe packaging when not in use.
-

European Hazardous Location Approval

The following modules are European Zone 2 approved: 1794-IB8, 1794-IB16.

European Zone 2 Certification (The following applies when the product bears the Ex Marking)

This equipment is intended for use in potentially explosive atmospheres as defined by European Union Directive 94/9/EC and has been found to comply with the Essential Health and Safety Requirements relating to the design and construction of Category 3 equipment intended for use in potentially explosive atmospheres, given in Annex II to this Directive. Compliance with the Essential Health and Safety Requirements has been assured by compliance with EN 60079-15 and EN 60079-0.





WARNING: Observe the following additional Zone 2 certification requirements.

- This equipment is not resistant to sunlight or other sources of UV radiation.
 - This equipment must be installed in an enclosure providing at least IP54 protection when applied in Zone 2 environments.
 - This equipment shall be used within its specified ratings defined by Allen-Bradley.
 - Provision shall be made to prevent the rated voltage from being exceeded by transient disturbances of more than 40% when applied in Zone 2 environments
 - This equipment must be used only with ATEX certified backplanes.
 - Secure any external connections that mate to this equipment by using screws, sliding latches, threaded connectors, or other means provided with this product.
 - Do not disconnect equipment unless power has been removed or the area is known to be nonhazardous.
-

North American Hazardous Location Approval

The following modules are North American Hazardous Location approved: 1794-IB8, 1794-IB16, 1794-IB32.

The following information applies when operating this equipment in hazardous locations:	Informations sur l'utilisation de cet équipement en environnements dangereux:
<p>Products marked "CL I, DIV 2, GP A, B, C, D" are suitable for use in Class I Division 2 Groups A, B, C, D, Hazardous Locations and nonhazardous locations only. Each product is supplied with markings on the rating nameplate indicating the hazardous location temperature code. When combining products within a system, the most adverse temperature code (lowest "T" number) may be used to help determine the overall temperature code of the system. Combinations of equipment in your system are subject to investigation by the local Authority Having Jurisdiction at the time of installation.</p>	<p>Les produits marqués "CL I, DIV 2, GP A, B, C, D" ne conviennent qu'à une utilisation en environnements de Classe I Division 2 Groupes A, B, C, D dangereux et non dangereux. Chaque produit est livré avec des marquages sur sa plaque d'identification qui indiquent le code de température pour les environnements dangereux. Lorsque plusieurs produits sont combinés dans un système, le code de température le plus défavorable (code de température le plus faible) peut être utilisé pour déterminer le code de température global du système. Les combinaisons d'équipements dans le système sont sujettes à inspection par les autorités locales qualifiées au moment de l'installation.</p>
<div style="display: flex; align-items: center;">  <div> <p>EXPLOSION HAZARD</p> <ul style="list-style-type: none"> • Do not disconnect equipment unless power has been removed or the area is known to be nonhazardous. • Do not disconnect connections to this equipment unless power has been removed or the area is known to be nonhazardous. Secure any external connections that mate to this equipment by using screws, sliding latches, threaded connectors, or other means provided with this product. • Substitution of components may impair suitability for Class I, Division 2. • If this product contains batteries, they must only be changed in an area known to be nonhazardous. </div> </div>	<div style="display: flex; align-items: center;">  <div> <p>RISQUE D'EXPLOSION</p> <ul style="list-style-type: none"> • Couper le courant ou s'assurer que l'environnement est classé non dangereux avant de débrancher l'équipement. • Couper le courant ou s'assurer que l'environnement est classé non dangereux avant de débrancher les connecteurs. Fixer tous les connecteurs externes reliés à cet équipement à l'aide de vis, loquets coulissants, connecteurs filetés ou autres moyens fournis avec ce produit. • La substitution de composants peut rendre cet équipement inadapté à une utilisation en environnement de Classe I, Division 2. • S'assurer que l'environnement est classé non dangereux avant de changer les piles. </div> </div>



ATTENTION: FLEX™ I/O is grounded through the DIN rail to chassis ground. Use zinc plated yellow-chromate steel DIN rail to assure proper grounding. The use of other DIN rail materials (for example, aluminum or plastic) that can corrode, oxidize, or are poor conductors, can result in improper or intermittent grounding. Secure DIN rail to mounting surface approximately every 200 mm (7.8 in.) and use end-anchors appropriately.



ATTENTION: To comply with the CE Low Voltage Directive (LVD), this equipment must be powered from a source compliant with the following: Safety Extra Low Voltage (SELV) or Protected Extra Low Voltage (PELV).

Compatibility

The following communication adapters are required to ensure compatibility with the 1794-IB32:

Remote I/O	1794-ASB series E or later 1794-ASB2 series D or later
ControlNet	1794-ACN15 series C, firmware revision 4.1 or later 1794-ACNR15 series C, firmware revision 4.1 or later
DeviceNet	1794-ADN Series B, firmware revision 2.4 or greater for out-of-box compatibility
Ethernet	1794-AENT series A, firmware revision 2.4 or later
PROFIBUS	1794-APB series A, version 1.1 of the GSD file (You can download the GSD file at www.ab.com/networks/gsd .)
ControlLogix Family	RSLogix5000 programming software, version 11 or later

Install Your Digital Input Module

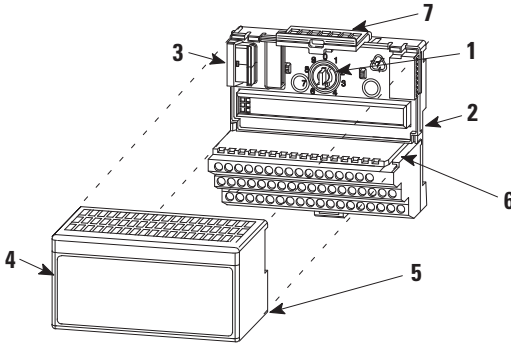

	Description		Description
1	Keyswitch	5	Alignment bar
2	Terminal base	6	Groove
3	Flexbus connector	7	Latching mechanism
4	Module		

The module mounts on a 1794 terminal base.



ATTENTION: During mounting of all devices, be sure that all debris (metal chips, wire strands, etc.) is kept from falling into the module. Debris that falls into the module could cause damage on power up.

1. Rotate the keyswitch (1) on the terminal base (2) clockwise to position 2 as required for this type of module.
2. Make certain the flexbus connector (3) is pushed all the way to the left to connect with the neighboring terminal base/adaptor. **You cannot install the module unless the connector is fully extended.**

8 FLEX I/O Digital Input Modules

3. Make sure the pins on the bottom of the module are straight so they will align properly with the connector in the terminal base.
-



WARNING: If you insert or remove the module while backplane power is on, an electrical arc can occur. This could cause an explosion in hazardous location installations. Be sure that power is removed or the area is nonhazardous before proceeding.

4. Position the module (4) with its alignment bar (5) aligned with the groove (6) on the terminal base.
5. Press firmly and evenly to seat the module in the terminal base unit. The module is seated when the latching mechanism (7) is locked into the module.

Connect Wiring for the 1794-IB8 and 1794-IB16 using a 1794-TB3 or 1794-TB3S

1. Connect individual input wiring to numbered terminals on the 0...15 row (A) as indicated in the Wiring Connections for 1794-IB8 and 1794-IB16 table.
2. Connect the associated +V DC power lead of the input device to the corresponding terminal on the 34...51 row (C) for each input as indicated in the Wiring Connections for 1794-IB8 and 1794-IB16 table. (The +V power terminals of row (C) are internally connected together.)
3. Connect the associated input common (3-wire devices only) to the corresponding terminal on the 16...33 row (B) for each input as indicated in the Wiring Connections for 1794-IB8 and 1794-IB16 table. (Commons are internally connected together.)
4. Connect +V DC power to terminal 34 on the 34...51 row (C).
5. Connect DC common to terminal 16 on the 16...33 row (B).
6. If daisy chaining power to the next terminal base, connect a jumper from terminal 51 (+V DC) on this base unit to terminal 34 on the next base unit.
7. If continuing DC common to the next base unit, connect a jumper from terminal 33 (common) on this base unit to terminal 16 on the next base unit.

Wiring Connections for 1794-IB8 and 1794-IB16 (use with 1794-TB3 or 1794-TB3S Terminal Base Unit)

Input ⁽¹⁾	Input Terminal	Voltage Terminal	Common Terminal ⁽²⁾
Input 0	A-0	C-35	B-17
Input 1	A-1	C-36	B-18
Input 2	A-2	C-37	B-19
Input 3	A-3	C-38	B-20
Input 4	A-4	C-39	B-21
Input 5	A-5	C-40	B-22
Input 6	A-6	C-41	B-23
Input 7	A-7	C-42	B-24
Input 8	A-8	C-43	B-25
Input 9	A-9	C-44	B-26
Input 10	A-10	C-45	B-27
Input 11	A-11	C-46	B-28
Input 12	A-12	C-47	B-29
Input 13	A-13	C-48	B-30
Input 14	A-14	C-49	B-31
Input 15	A-15	C-50	B-32
+V DC	C-34...C-51		
Common	B-16...B-33		

⁽¹⁾ 1794-IB8: Inputs 0...7; 1794-IB16: Inputs 0...15.

⁽²⁾ 2-wire input devices use signal and supply terminals; 3-wire devices use signal, return and supply terminals.

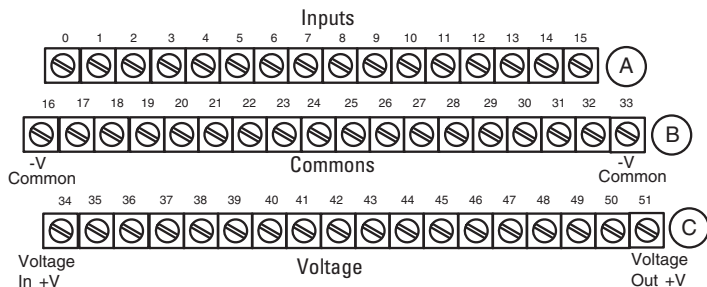
1794-TB3 and 1794-TB3S Terminal Base Wiring for 1794-IB8 and 1794-IB16

Connect V common to terminal B-16.

(1794-TB3 shown)

Connect +V to terminal C-34.

Use B-33 and C-51 to daisy-chain to the next terminal base unit.

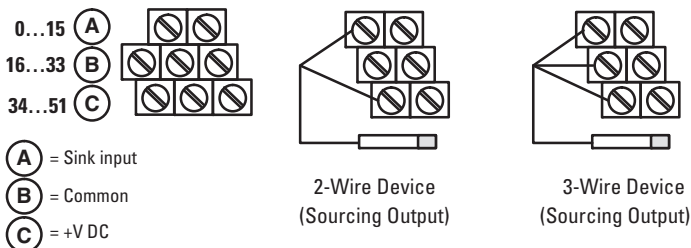
2-Wire and 3-Wire Input Wiring for 1794-IB8 and 1795-IB16**Connect Wiring for the 1794-IB32 using a 1794-TB32 or 1794-TB32S**

1. Connect individual input wiring (IN0...IN15) to numbered terminals on the 0...15 row (A) as indicated in the Wiring Connections for 1794-IB32 table.
2. Connect the associated power to the +V1 terminal (35, 37, 39, or 41) on the 34...51 row (C) as indicated in the Wiring Connections for 1794-IB32 table.
3. Connect the associated common for IN0...IN15 to COM1 (terminal 36, 38, 40, or 42) on the 34...51 row (C) as indicated in the Wiring Connections for 1794-IB32 table.

4. Connect individual input wiring (IN16...IN31) to numbered terminals on the 16...33 row (B) as indicated in the Wiring Connections for 1794-IB32 table. **Do not connect to terminals 16 or 33.**
5. Connect the associated power to the +V2 terminal (43, 45, 47, or 49) on the 34...51 row (C) as indicated in the Wiring Connections for 1794-IB32 table.
6. Connect the associated common for IN16...IN31 to COM2 (terminal 44, 46, 48, or 50) on the 34...51 row (C).
7. If continuing input wiring power for IN0...IN15 to the next terminal base, connect a jumper from terminal 41 (+V1) on this terminal base unit to the power terminal on the next terminal base unit. (Refer to the installation instructions for the specific terminal base unit.
8. If continuing input wiring IN0...IN15 common to the next terminal base, connect a jumper from terminal 42 (COM1) on this terminal base unit to the common terminal on the next terminal base unit.
9. If continuing input wiring power for IN16...IN31 to the next terminal base, connect a jumper from terminal 49 (+V2) on this terminal base unit to the power terminal on the next terminal base unit. (Refer to the installation instructions for the specific terminal base unit.
10. If continuing input wiring IN16...IN31 common to the next terminal base, connect a jumper from terminal 50 (COM2) on this terminal base unit to the common terminal on the next terminal base unit.

Wiring Connections for 1794-IB32 (use with 1794-TB32 or 1794-TB32S Terminal Base Unit)

Input	Signal	Input	Signal
Input 0	A-0	IN 16	B-17
Input 1	A-1	IN 17	B-18
Input 2	A-2	IN 18	B-19
Input 3	A-3	IN 19	B-20
Input 4	A-4	IN 20	B-21
Input 5	A-5	IN 21	B-22
Input 6	A-6	IN 22	B-23
Input 7	A-7	IN 23	B-24
Input 8	A-8	IN 24	B-25

Wiring Connections for 1794-IB32 (use with 1794-TB32 or 1794-TB32S Terminal Base Unit)

Input	Signal	Input	Signal
Input 9	A-9	IN 25	B-26
Input 10	A-10	IN 26	B-27
Input 11	A-11	IN 27	B-28
Input 12	A-12	IN 28	B-29
Input 13	A-13	IN 29	B-30
Input 14	A-14	IN 30	B-31
Input 15	A-15	IN 31	B-32
+V1 DC power ⁽¹⁾ (inputs IN0...IN15)	Power terminals 35, 37, 39, and 41 for IN0...IN15. +V1 connected to terminals 35, 37, 39, and 41.		
COM1 DC Return (inputs IN0...IN15)	Common terminals 36, 38, 40, and 42 for IN0...IN15. V1 Return connected to terminals 36, 38, 40, and 42.		
+V2 DC power (inputs IN16...IN31)	Power terminals 43, 45, 47, and 49 for IN16...IN31. +V2 connected to terminals 43, 45, 47, and 49.		
COM2 DC Return (inputs IN16...IN31)	Common terminals 44, 46, 48, and 50 for IN16...IN31. V2 Return connected to terminals 44, 46, 48, and 50.		

⁽¹⁾ 2-wire input devices use signal and supply terminals; 3-wire devices use signal, return and supply terminals.

1794-TB32 and 1794-TB32S Terminal Base Wiring for 1794-IB32

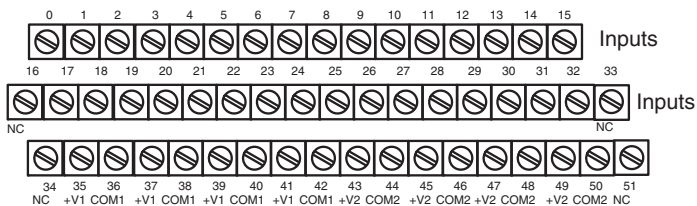

+V1 = Terminals 35, 37, 39, and 41 (1794-TB32 shown)

+V2 = Terminals 43, 45, 47, and 49

COM1 = Terminals 36, 38, 40, and 42

COM2 = Terminals 44, 46, 48, and 50

NC = No connections (terminals 16, 33, 34, and 51)

Configure Your Input Module

Configure your input module by setting bits in the configuration word (write word).

Image Table Memory Map for the 1794-IB8 Module

Dec	15	14	13	12	11	10	9	8	7	6	5	4	3	2	1	0
Oct	17	16	15	14	13	12	11	10	7	6	5	4	3	2	1	0
Read 1	Not used								I7	I6	I5	I4	I3	I2	I1	I0
Write 1	Not used												Input Filter 0...7			
Where	I = Input															

Image Table Memory Map for the 1794-IB16 Module

Dec	15	14	13	12	11	10	9	8	7	6	5	4	3	2	1	0
Oct	17	16	15	14	13	12	11	10	7	6	5	4	3	2	1	0
Read 1	I15	I14	I13	I12	I11	I10	I9	I8	I7	I6	I5	I4	I3	I2	I1	I0
Read 2	C = Counter Input value of input 15															
Write 1	Not used		CF	CR							Input Filter 12...15			Input Filter 0...11		
Where	I = Input C = Counter value for input 15 CF = Counter fast – where 1 = fast input (raw data), 0 standard input filtered data CR = Counter reset															
Note:	C, CR, and CF not available when used with any series 1794-ASB or 1794-ASB2 remote I/O adapter modules.															

Image Table Memory Map for the 1794-IB32 Module

Dec	15	14	13	12	11	10	9	8	7	6	5	4	3	2	1	0
Oct	17	16	15	14	13	12	11	10	7	6	5	4	3	2	1	0
Read 1	I15	I14	I13	I12	I11	I10	I9	I8	I7	I6	I5	I4	I3	I2	I1	I0
Read 2	I31	I30	I29	I28	I27	I26	I25	I24	I23	I22	I21	I20	I19	I18	I17	I16
Write 1	Not used					Input Filter FT 0...31			Not used							
Where	I = Input status FT = Input filter time															

14 FLEX I/O Digital Input Modules

Set the Input Filter Time

To set the input filter time, set the associated bits in the output image table (complementary word) for the module.

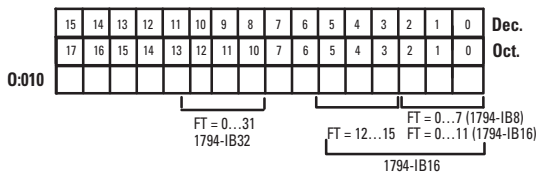

For example, to increase the off-to-on filter time to 4 ms for all inputs at address rack 1, module group 0, (using 1794-IB32 as an example), set bits and program as shown below.

Write filter time on system startup.

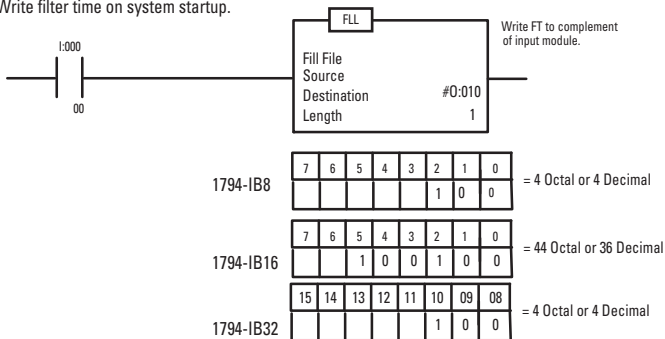

Refer to the Input Filter Time table for other bit settings.

Input Filter Time

Bits			Description	Filter Time
02	01	00	Inputs 0...7 (1794-IB8)	1794-IB8, 1794-IB16, 1794-IB32
02	01	00	Inputs 0...11 (1794-IB16)	
05	04	03	Inputs 12...15 (1794-IB16)	
10	09	08	Inputs 0...32 (1794-IB32)	Off to On/On to Off
0	0	0	Filter Time 0 (Default)	0.25 ms
0	0	1	Filter Time 1	0.5 ms
0	1	0	Filter Time 2	1 ms
0	1	1	Filter Time 3	2 ms
1	0	1	Filter Time 4	4 ms
1	0	1	Filter Time 5	8 ms
1	1	0	Filter Time 6	16 ms
1	1	1	Filter Time 7	32 ms

Specifications

Specifications – 1794-IB8

Attribute	Value
Number of inputs	8, current, sinking
Recommended terminal base unit	1794-TB3, 1794-TB3S, 1794-TB3K, 1794-TB3SK, 1794-TBKD, 1794-TB37DS
On-state voltage, min	10V DC
On-state voltage, nom	24V DC
On-state voltage, max	31.2V DC
On-state current, min	2.0 mA
On-state current, nom	8.0 mA
On-state current, max	12.0 mA
Off-state voltage, max	5.0V DC
Off-state current, max	1.5 mA
Nominal input impedance	4.6 k Ω
Isolation voltage	50V (continuous), Basic Insulation Type Type tested @ 850V DC for 60 s, between field side and system No isolation between individual channels
FlexBus current	20 mA @ 5V DC
Power dissipation, max	3.5 W @ 31.2V DC
Thermal dissipation, max	11.9 BTU/hr @ 31.2V DC

Specifications – 1794-IB16

Attribute	Value
Number of inputs	16, current, sinking
Recommended terminal base unit	1794-TB3, 1794-TB3S, 1794-TB3K, 1794-TB3SK, 1794-TBKD, 1794-TB37DS
On-state voltage, min	10V DC
On-state voltage, nom	24V DC
On-state voltage, max	31.2V DC
On-state current, min	2.0 mA
On-state current, nom	8.0 mA

Specifications – 1794-IB16

Attribute	Value
On-state current, max	12.0 mA
Off-state voltage, max	5.0V DC
Off-state current, max	1.5 mA
Nominal input impedance	4.6 k Ω
Isolation voltage	50V (continuous), Basic Insulation Type Type tested @ 707V DC for 60 s, between field side and system No isolation between individual channels
FlexBus current	30 mA @ 5V DC
Power dissipation, max	6.1 W @ 31.2V DC
Thermal dissipation, max	20.8 BTU/hr @ 31.2V DC

Specifications – 1794-IB32

Attribute	Value
Number of inputs	32, current, sinking
Recommended terminal base unit	1794-TB32, 1794-TB32S, 1794-TB62DS, 1794-TB62EXD4X15
On-state voltage, min	19.2V DC
On-state voltage, nom	24V DC
On-state voltage, max	31.2V DC
On-state current, min	2.0 mA
On-state current, nom	4.1 mA @ 24V DC
On-state current, max	6.0 mA
Off-state voltage, max	5.0V DC
Off-state current, max	1.5 mA
Nominal input impedance	22.2 k Ω
Isolation voltage	50V (continuous), Basic Insulation Type Type tested @ 2121V DC for 2 s, between field side and system No isolation between individual channels
FlexBus current	30 mA @ 5V DC
Power dissipation, max	6.0 W @ 31.2V DC
Thermal dissipation, max	20.47 BTU/hr @ 31.2V DC

General Specifications

Attribute	Value
Input filter time	Refer to Input Filter Time table
Terminal base screw torque	Determined by installed terminal base
Dimensions, approx. (H x W x D)	94 x 94 x 69 mm (3.7 x 3.7 x 2.7 in.)
Indicators (field side indication)	8 yellow status indicators – 1794-IB8 16 yellow status indicators – 1794-IB16 32 yellow status indicators – 1794-IB32
External DC power supply voltage, nom	24V DC
External DC power voltage range	10...31.2V DC (includes 5% AC ripple) – 1794-IB8, 1794-IB16 19.2...31.2V DC (includes 5% AC ripple) – 1794-IB32
North American temperature code	T3C – 1794-IB8, 1794-IB32 T4A – 1794-IB16
IEC temperature code	T3 – 1794-IB8 only T4 – 1794-IB16 only
Keyswitch position	2
Enclosure type rating	None (open-style)
Wire size	Determined by installed terminal base
Wiring category ⁽¹⁾	2 – on signal ports

⁽¹⁾ Use this conductor category information for planning conductor routing as described in Industrial Automation Wiring and Grounding Guidelines, publication [1770-4.1](#).

Environmental Specifications

Attribute	Value
Operating temperature	IEC 60068-2-1 (Test Ad, Operating Cold), IEC 60068-2-2 (Test Bd, Operating Dry Heat), IEC 60068-2-14 (Test Nb, Operating Thermal Shock): -20...55 °C (-4...131 °C) – 1794-IB8, 1794-IB16 0...55 °C (32...131 °F) – 1794-IB32
Storage temperature	IEC 60068-2-1 (Test Ab, Unpackaged Non-operating Cold), IEC 60068-2-2 (Test Bb, Unpackaged Non-operating Dry Heat), IEC 60068-2-14 (Test Na, Unpackaged Non-operating Thermal Shock): -40...85 °C (-40...185 °F)
Relative humidity	IEC 60068-2-30 (Test Db, Unpackaged Damp Heat): 5...95% non-condensing
Vibration	IEC60068-2-6 (Test Fc, Operating): 5 g @ 10...500 Hz

Environmental Specifications

Attribute	Value
Shock, operating	IEC60068-2-27 (Test Ea, Unpackaged shock): 30 g
Shock, nonoperating	IEC60068-2-27 (Test Ea, Unpackaged shock): 50 g
Emissions	CISPR 11: Group 1, Class A (with appropriate enclosure)
ESD immunity	IEC 61000-4-2: 6 kV contact discharges 8 kV air discharges
Radiated RF immunity	(1794-IB8, 1794-IB16) IEC 61000-4-3: 10V/m with 1 kHz sine-wave 80% AM from 80...2000 MHz 10V/m with 200 Hz 50% Pulse 100% AM @ 900 MHz 10V/m with 200 Hz 50% Pulse 100% AM @ 1890 MHz 3V/m with 1 kHz sine-wave 80% AM from 2000...2700 MHz (1794-IB32) 10V/m with 1 kHz sine-wave 80% AM from 80...1000 MHz
EFT/B immunity	IEC 61000-4-4: ±2 kV @ 5 kHz on power ports ±2 kV @ 5 kHz on signal ports
Surge transient immunity	IEC 61000-4-5: ±1 kV line-line(DM) and ±2 kV line-earth(CM) on signal ports
Conducted RF immunity	IEC 61000-4-6: 10V rms with 1 kHz sine-wave 80% AM from 150 kHz...80 MHz

Certifications

Certifications (when product is marked) ⁽¹⁾	Value
c-UL-us	<p>UL Listed Industrial Control Equipment, certified for US and Canada. See UL File E65584.</p> <p>UL Listed for Class I, Division 2, Group A, B, C, D Hazardous Locations, certified for US and Canada. See UL File 194810.</p>
CSA	<p>(1794-IB8 and 1794-IB16 only) CSA Certified Process Control Equipment. See CSA File LR54689C.</p> <p>CSA Certified Process Control Equipment for Class I, Division 2, Group A, B, C, D Hazardous Locations. See CSA File LR69960C.</p>
CE	<p>European Union 2004/108/EC EMC Directive, compliant with: EN 61326-1; Meas./Control/Lab., Industrial Requirements EN 61000-6-2; Industrial Immunity EN 61000-6-4; Industrial Emissions EN 61131-2; Programmable Controllers (Clause 8, Zone A & B)</p>
Ex	<p>(1794-IB8) European Union 94/9/EC ATEX Directive, compliant with: EN 60079-15:2010; Potentially Explosive Atmospheres, Protection "n" EN 60079-0:2009; General Requirements LCIE 01ATEX6020X II 3 G Ex nA IIC T3 Gc</p> <p>(1794-IB16) European Union 94/9/EC ATEX Directive, compliant with: EN 60079-15:2010; Potentially Explosive Atmospheres, Protection "n" EN 60079-0:2009; General Requirements DEMKO 14ATEX1342501X EN 60079-0:2012+A11:2013 IECEx UL 14.0066X IEC 60079-0, 6th Edition IEC 60079-15, 4th Edition II 3 G Ex nA IIC T4 Gc</p>
TÜV	<p>(1794-IB16 only) TÜV Certified for Functional Safety: up to and including SIL 2</p>
KC	<p>Korean Registration of Broadcasting and Communications Equipment, compliant with: Article 58-2 of Radio Waves Act, Clause 3</p>
EAC	<p>Russian Customs Union TR CU 020/2011 EMC Technical Regulation</p>
RCM	<p>Australian Radiocommunications Act, compliant with: AS/NZS CISPR 11; Industrial Emissions</p>

(1) See the Product Certification link at www.ab.com for Declarations of Conformity, Certificates, and other certification details.

Derating Chart for 1794-IB16

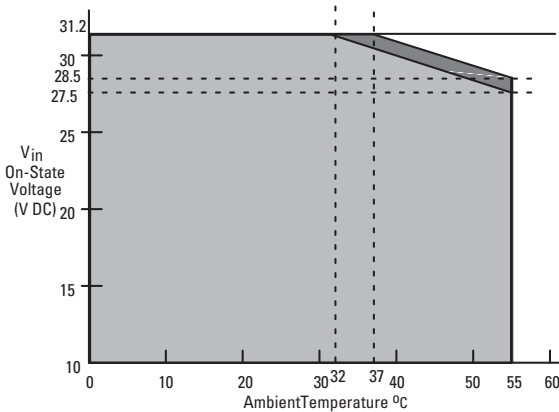

The area within the curve represents the safe operating range for the module under various conditions of user supplied 24V DC supply voltages and ambient temperature.

- = Normal mounting safe operating range, (includes).
- = Other mounting positions (including inverted horizontal) safe operating range

Normal Mounting – Horizontal

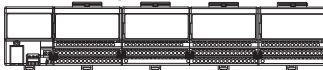

Other Mounting (including Vertical, and Inverted Horizontal Mounting)

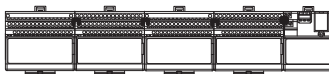

Voltage (max.)	Temperature (max.)		Voltage (max.)	Temperature (max.)	
	Normal	Other		Normal	Other
31.2	37	32	29.0	51	45
30.5	41	36	28.5	55	48
30.0	45	39	28.0		51
29.5	48	42	27.5		55

Rockwell Automation Support

Rockwell Automation provides technical information on the Web to assist you in using its products. At <http://www.rockwellautomation.com/support/>, you can find technical manuals, a knowledge base of FAQs, technical and application notes, sample code and links to software service packs, and a MySupport feature that you can customize to make the best use of these tools.

For an additional level of technical phone support for installation, configuration and troubleshooting, we offer TechConnect support programs. For more information, contact your local distributor or Rockwell Automation representative, or visit <http://www.rockwellautomation.com/support/>.

Installation Assistance

If you experience a problem within the first 24 hours of installation, please review the information that's contained in this manual. You can also contact a special Customer Support number for initial help in getting your product up and running.

United States or Canada	1.440.646.3434
Outside United States or Canada	Use the Worldwide Locator at http://www.rockwellautomation.com/support/americas/phone_en.html , or contact your local Rockwell Automation representative.

New Product Satisfaction Return

Rockwell Automation tests all of its products to ensure that they are fully operational when shipped from the manufacturing facility. However, if your product is not functioning and needs to be returned, follow these procedures.

United States	Contact your distributor. You must provide a Customer Support case number (call the phone number above to obtain one) to your distributor to complete the return process.
Outside United States	Please contact your local Rockwell Automation representative for the return procedure.

Documentation Feedback

Your comments will help us serve your documentation needs better. If you have any suggestions on how to improve this document, complete this form, publication [RA-DU002](#), available at <http://www.rockwellautomation.com/literature/>.

Allen-Bradley, Rockwell Automation, FLEX I/O, and TechConnect are trademarks of Rockwell Automation, Inc.

Trademarks not belonging to Rockwell Automation are property of their respective companies.

Rockwell Otomasyon Ticaret A.Ş., Kar Plaza İş Merkezi E Blok Kat:6 34752 İçerenköy, İstanbul, Tel: +90 (216) 5698400

www.rockwellautomation.com

Power, Control and Information Solutions Headquarters

Americas: Rockwell Automation, 1201 South Second Street, Milwaukee, WI 53204-2496 USA, Tel: (1) 414.382.2000, Fax: (1) 414.382.4444
Europe/Middle East/Africa: Rockwell Automation, Voorlaan/Boulevard du Souverain 36, 1170 Brussels, Belgium, Tel: (32) 2 663 0600, Fax: (32) 2 663 0640
Asia Pacific: Rockwell Automation, Level 14, Core F, Cyberport 3, 100 Cyberport Road, Hong Kong, Tel: (852) 2887 4788, Fax: (852) 2508 1846

Publication 1794-IN093D-EN-P - July 2015

Supersedes Publication 1794-IN093C-EN-P - December 2009

Copyright © 2015 Rockwell Automation, Inc. All rights reserved.